

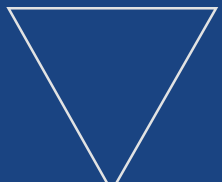

CARRIERS AND FLUSH PLATES



Water, as future.



From Portugal to the world

OLI is the biggest manufacturer of flushing carriers in South Europe and partner to the leading worldwide players of ceramic sanitary ware.

The company was founded in Aveiro in 1954, in the center region of Portugal. From its large and modern industrial manufacturing plant, recognized for its productive efficiency, OLI exports 80% of its production to over 80 countries in five continents. Today, OLI is a global brand that can be found in bathrooms all over the world. From a luxurious hotel in Dubai to a modern hospital in Israel, from the new football stadium in Qatar to tourist restaurants in Italy. OLI also relies on the customization of its bathroom solutions to meet the needs of each market, as well as to obtain varied international certifications to authenticate the quality and safety of its products in the regions in which it is present.

Innovation in the brand DNA

- The OLI factory never sleeps. Daily, its R&D Center studies new water-efficient solutions for a comfortable and inclusive bathroom. Innovation defines its DNA as its signature, "Inspired by Water", expresses OLI's mission to place innovation at the service of water preservation with the goal of defending this scarce natural resource in which life on this planet depends on. The dual flush mechanism (1994), which contributed to the reduction of 50% of water usage, was its first breakthrough project. The mass production of this water-saving solution brought tremendous environmental and economic benefits at a world scale. This invention has been accompanied by various simple solutions that have revolutionized our perception and experience of bathroom spaces.

Design and author identity

- From inlet valves that assure a quick and silent filling of the tank, to resistant frame structures that allow the user to adjust the height of the toilet, to the flush plates designed by world-renowned architects, OLI has built a valuable portfolio, where innovative carriers assume a central role. By utilizing patented technology and maintaining high manufacturing standards, the brand offers products suitable for new construction, rehabilitation and renovation projects. These products are distinguished by their contemporary design, use of high-quality materials and functional features. In recent years OLI has strengthened its ties and invested in architectural projects, establishing new partnerships with renowned figures such as Álvaro Siza Viera (Pritzker Award 1992), Eduardo Souto de Moura (Pritzker Award 2011), Romano Aldolini, and Alessio Pinto, all of whom have earned top accolades in the design field. OLI is one of the Portuguese companies with the most patents registered in Europe: currently holding 38 active patents. This strategy of creating value and of concentration on the culture of knowledge and innovation, has been recognised with many awards - Millennium Horizontes, Archiproducts Design Award, Good Design, Iconic Awards, Design Plus, Red Dot Design Award, IF Design, KBB and DPHA, OLI thus fulfills its vision: to be a company of excellence recognized for innovation and the creation of value for all.

OLI in Numbers

Turnover
90 MILLION \$

Production volume annual
2 MILLION
carriers

7 MILLION
flushing mechanisms

144 MILLION
injected components

INTERNATIONALISATION
80 MARKETS

6 COMMERCIAL BRANCHES
(Spain, Germany, Italy, Russia, Norway and France)

38 PATENTS

473 EMPLOYEES



Water, as future.

Water, this gift that hydrates us and irrigates the fields that provide us with nourishment. This sea in which we navigate, this rain that holds the world in balance. What future awaits it? What future awaits us?

“Water, as the future.” is more than a statement, it is a belief in responding to the threat that involves water. This is what drives us at OLI every day. Contributing to saving water, the efficiency of its use, the sustainability of its origin and the respect for this element at every moment of its use. It is recognizing that there is a learning process to be undertaken and that this is the time for it.

We are concerned just as we are motivated by the knowledge that throughout our history we have contributed towards more responsible and sustainable water consumption. Flushing with reduced water consumption and making more efficient use of water in the bathroom are integral to OLI’s principles, and this also contributes to our future.

70%*

of water consumption in a house takes place in the bathroom

24%*

of water consumption in the bathroom takes place in flushing

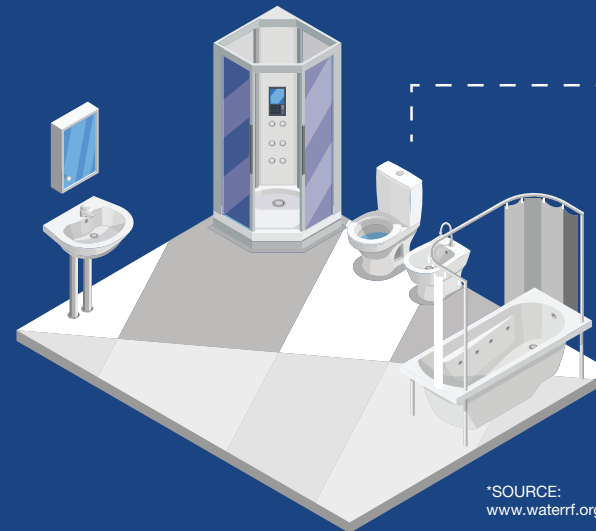

*SOURCE:
www.waterrf.org

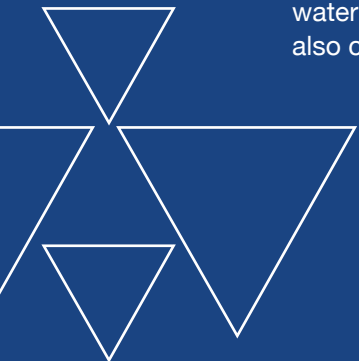

Decades of Innovation

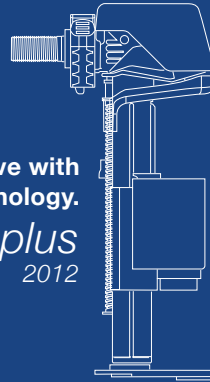

1st inlet valve with Plus* Technology.
azor plus
2012

The Less Is More concept linked with water consumption.
Award winner Less Is More Flush Plate

Less Is More
2022

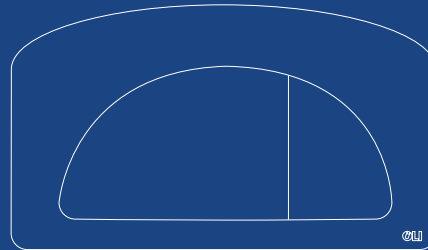
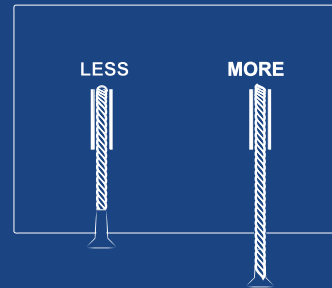

1st flush plate with dual flush option

gidi
1999

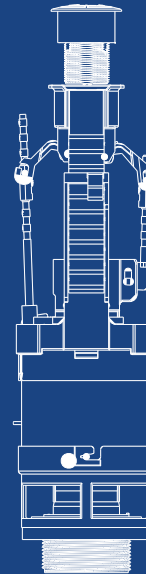

The Invention of the first Dual Flush outlet valve

NVDF
1995

Azor Plus Technology
Save Water

2,4 Gallons*

water / day

*The Plus inlet valve saves up to 9 litres of water per day, corresponding to a 12% reduction in the water consumption, based on average usage in a single-family home for 4 people with cisterns without the Plus inlet valve.

PROJECTS WORLDWIDE



BNP PARIBAS FORTIS - BRUSSELS

The new headquarters of BNP Paribas Fortis bank in Brussels, is an “architectural jewel” and passive building that meets the highest standards of innovation and environmental performance.

Located in Warandeberg, in the heart of the Belgian capital, the building has a floor area of more than 100,000 square metres and houses 4,100 workplaces, making it one of the largest office buildings in Belgium.

The bathrooms of this building were equipped with **OLI120 PLUS SANITARBLOCK** in-wall carriers and **SLIM Soft-touch black** flush plates.

KATARA TOWERS: DOHA - QATAR

Katara Towers are a new icon in Qatar. Symbolically intertwined with Qatar’s heritage, the Iconic Towers in Lusail are an architectural translation of Qatar’s national seal, representing the traditional scimitar swords.

In these two towers, which house two hotels, we can find the **OLI74 PLUS Sanitarblock** in-wall carriers as well as the **SLIM Polished Gold** and **OCEANIA MIA** flush plates.



PROJECTS WORLDWIDE



IBEROSTAR MIRAFLORES HOTEL - PERU

The Iberostar Miraflores Hotel, in Lima - Peru, is the first single-use plastic-free hotel. Promoting the circular economy is one of the purposes of this 5-star hotel that presents us with an inspiring design and offers a warm and welcoming atmosphere, without giving up the avant-garde style of the new construction.

Keeping the bet on sustainability, they chose **OLI74 PLUS SANITARBLOCK** in-wall carriers with **GLOBE Black Soft-touch** flush plates for their bathroom spaces.

DU MUSÉE - CANADA

Du Musée is an elegant enclave that blends historical Victorian trimmings with modern sensibilities, on a quiet street dotted with breathtaking sculptures and installations. To equip the bathrooms of the townhouses and condominiums, were chosen the **OLI74 PLUS** and a few different flush plates, the **SLIM** model being the most requested.



OLI In-Wall Carrier Advantages



Universal Installation



- Fits all Toilet models
- 3.54" (90mm) Minimum thickness

For 2 x 4 and 2 x 6 installation

Depth adjustable outlet bend



Polypropylene outlet bend, that connects the toilet to the waste pipe, rotates 45° and also adjusts in depth to match the construction site waste pipe. Adapts easily to 2 x 6 stud wall constructions

Height adjustable for optimal comfort

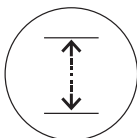

5.9" (150mm) adjustment



Silent Inlet Valve



- Class 1 Certified

Azor Plus Water Saving Delay System

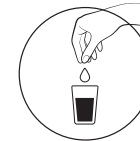

This is a system created by OLI in which the inlet valve delays the inflow of water into the tank to prevent extra water being used for flushing. While flushing takes place, no new water enters the tank.



Frame ultra resistant to corrosion



Frame tested for a 400kg load (882 lbs)



Easy Clean

The In-wall carrier installation allows easy access around the toilet area.



200,000
life cycle tested

OLI74 PLUS S90

879268	OLI74 PLUS S90 SANITARBLOCK	6L / 3L	1,6 GPF – 0,8 GPF	\$ 599.00
889825	OLI74 PLUS S90 SANITARBLOCK – ECO	4.8L / 3L	1,28 GPF – 0,8 GPF	\$ 625.00

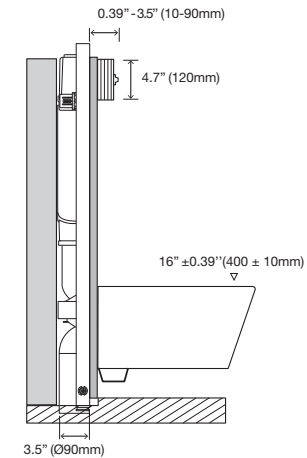
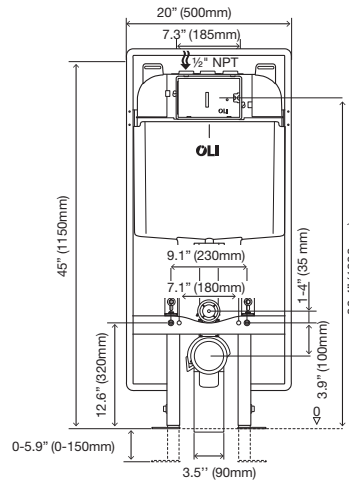

FEATURES

- Suitable for a 2 x 4 and a 2 x 6 stud wall installation;
- Compatible with all wall-hung toilets;
- Easy and quick installation;
- Depth adjustable outlet bend;
- Height adjustable for optimal comfort;
- Tested for a 400 kg static load (882 lbs);
- Oli flush plate required.

INCLUDED

- Toilet installation hardware;
- Frame installation hardware;
- Inlet and outlet toilet connectors;
- Outlet bend and 3.5" (90 mm)/ 4-21/64" (Ø110 mm) adaptor;
- G 1/2" stop valve;
- 3" DWV shielded.



Features and Installation

OLI74 PLUS S90 + RIA



601803	OLI74 PLUS S90 SANITARBLOCK + RIA CHROME (PC) PUSH PLATE	6L / 3L	1,6 GPF – 0,8 GPF	\$ 699.00
--------	--	---------	-------------------	-----------

RIA FLUSH PLATE INCLUDED

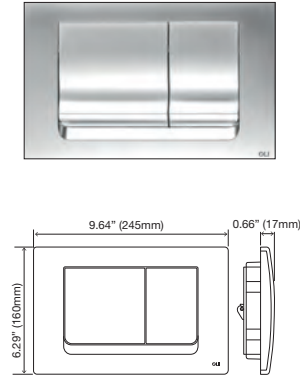
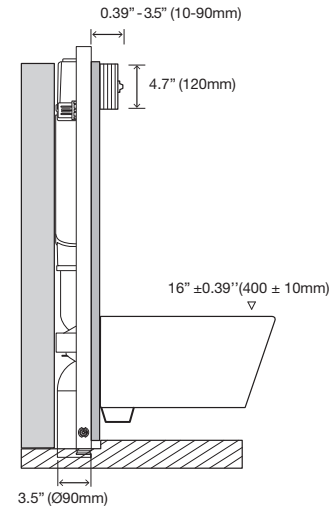
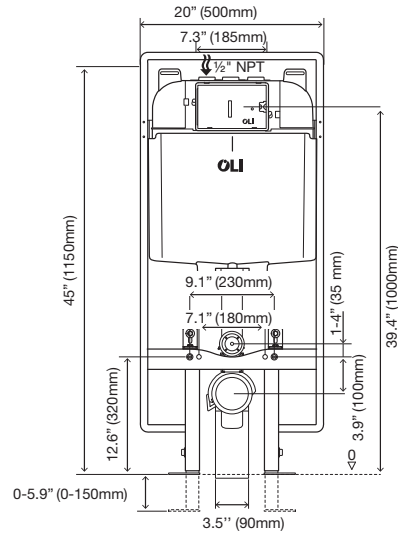

FEATURES

- Suitable for 2 x 4 stud wall installation;
- Compatible with all wall-hung toilets;
- Easy and quick installation;
- Depth adjustable outlet bend;
- Height adjustable for optimal comfort;
- GPF: 1.6 Full flush, 0.8 Eco-flush;
- Tested for a 400 kg load (882 lbs).

INCLUDED

- RIA polished chrome flush plate;
- Toilet installation hardware;
- Frame installation hardware;
- Inlet and outlet toilet connectors;
- Outlet bend and 3.5" (90 mm) / 4-21/64" (Ø110 mm) adaptor;
- G 1/2" stop valve;
- 3" DWV shielded.

RIA PLATE FEATURES

- ABS: high resistance to scratches;
- Mechanical actuation;
- Dual flush;
- Actuation force < 20 N;
- 0.669" (17mm) thick.

Please consult page 43 for all details concerning the RIA plate.



Features and Installation

OLI74 PLUS DIRECT

For Floormounted Toilets

884873 OLI74 PLUS DIRECT \$ 295.00

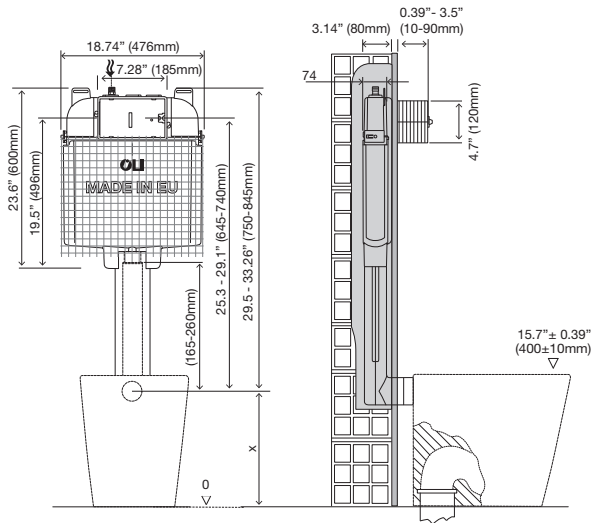

FEATURES

- Suitable for a 2 x 4 and 2 x 6 stud wall installation;
- Compatible with all floor mounted toilets;
- 3.14" (80mm) thick;
- Easy and quick installation;
- Oli flush plate required.



Features and Installation

ECO BIDET

008908 ECO BIDET \$ 295.00

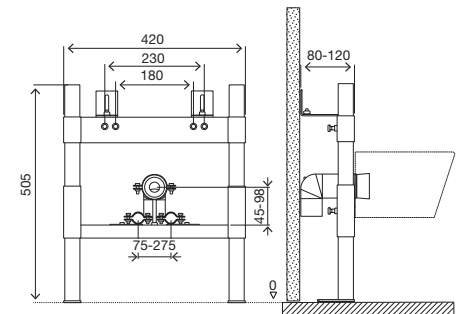

FEATURES

- Frame for wall-hung bidet;
- Suitable for 2 x 4 and 2 x 6 stud wall installation;
- Solid wall or drywall installation;
- Frame tested for a 400kg (882 lbs) load;
- Adjustable attachment plates;
- 3,14" (80mm) thick.

INCLUDED

- Bidet fixing material;
- Frame installation hardware;
- Outlet bend Ø 40 - 32/50 - 40.



Features and Installation

URINAL

136179

URINAL FRAME

\$ 595.00

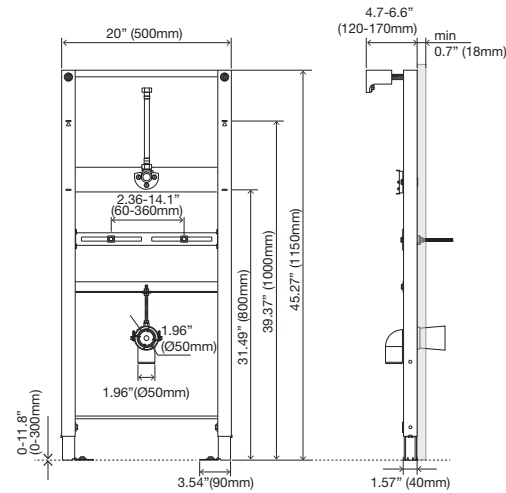

FEATURES

- Frame for wall-hung urinals;
- Solid wall or drywall installation;
- Easy and quick installation with Fast-Fit system;
- Frame tested for a 130kg (287 lbs) load;
- Height adjustable from 0 to 200mm (0 to 7,9");
- Adjustable attachment plates;
- Flush valve not included;
- The flush valve has to be installed before closing the wall;
- 4,72" (120mm) thick.

INCLUDED

- Frame fixing material;
- Outlet bend Ø 50/50;
- G ½" fitting for tap connection (adjustable);
- ½" flexible hose.



Features and Installation

QUICK REFERENCE GUIDE

Mechanical ABS Flush Plates

Globe Page 27



152949
Glossy White
\$ 145.00



885464
White Glossy
Antibacterial
\$ 145.00



152950
Polished Chrome
\$ 170.00



152951
Matte Chrome
\$ 170.00



152952
Black Soft-Touch
\$ 260.00



152953
Grey Soft-Touch
\$ 285.00



152954
Polished Gold
\$ 375.00

Slim Page 30



659041
Glossy White
\$ 145.00



659044
Polished Chrome
\$ 170.00



154962
Polished Gold
\$ 395.00

Slim Matte Collection



659046
Matte Chrome
\$ 170.00

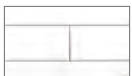

659042
White Matte
\$ 190.00



659058
Grey Matte
\$ 190.00



659056
Black Matte
\$ 190.00

Plain Page 39



070826
Glossy White
\$ 145.00



070827
Polished Chrome
\$ 195.00



070828
Matte Chrome
\$ 195.00



070829
Black Soft-Touch
\$ 195.00

Glam Page 35



139184
Glossy White
\$ 145.00



885578
White Glossy
Antibacterial
\$ 145.00



139185
Polished Chrome
\$ 160.00



139186
Matte Chrome
\$ 190.00



139187
Black Soft-Touch
\$ 190.00

Narrow Page 37



152939
Glossy White
\$ 145.00



885576
White Glossy
Antibacterial
\$ 145.00



152940
Polished Chrome
\$ 160.00



152941
Matte Chrome
\$ 210.00



152942
Black Soft-Touch
\$ 210.00

Ria Page 43



010230
Glossy White
\$ 145.00



640591
White Glossy
Antibacterial
\$ 145.00

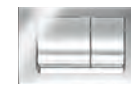

640584
Polished Chrome
\$ 120.00

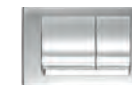

640586
Matte Chrome
\$ 165.00

Ria Start-Stop Page 45



010234
Glossy White
\$ 145.00



010244
Polished Chrome
\$ 145.00

Mechanical Stainless Steel Flush Plates

Less is more Page 21



883524
Polished
\$ 795.00



883525
Brushed
\$ 795.00



883526
White
\$ 895.00



883527
Black
\$ 895.00



888573
Brushed Gold
\$ 895.00

INO-X 02 Page 23



660002
Brushed
\$ 795.00

INO-X 06 Page 25



661006
Brushed
\$ 795.00

Slim Stainless Steel Page 31



057141
Brushed
\$ 395.00

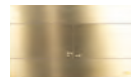

888565
Brushed Gold
\$ 630.00



888561
Brushed White
Gold
\$ 630.00



889312
Brushed Copper
\$ 630.00



889313
Brushed Gun Metal
\$ 630.00

Oceania Page 33



054561
Polished
\$ 575.00



054564
Brushed
\$ 575.00



882412
Brushed Gold
\$ 695.00

Oceania Mia Page 33



054563
MIA Mech
(Customizable)
\$ 475.00

Metal Page 41



656004
Polished Chrome
\$ 430.00



656006
Matte Chrome
\$ 490.00

QUICK REFERENCE GUIDE

Mechanical Glass Flush Plates

Oceania

Page 33



054554
White Glass
\$ 575.00



054557
Black Glass
\$ 575.00

Glass & Stainless Steel



054558
White Glass
Stainless Steel Button
\$ 695.00



054562
Black Glass
Stainless Steel Button
\$ 695.00

Pneumatic Glass

SM15

Page 57



022238
White Tempered Glass
Polished Chrome Buttons
\$ 795.00

Pneumatic ABS flush plates

Karisma

Page 53



641001
Glossy White
\$ 145.00



641004
Polished Chrome
\$ 195.00



641006
Matte Chrome
\$ 215.00



641015
Black Soft-Touch
\$ 225.00

Salina

Page 55



640081
Glossy White
\$ 145.00



640084
Polished Chrome
\$ 195.00



640086
Matte Chrome
\$ 240.00



640097
Black Soft-Touch -
Polished Chrome
\$ 240.00

Easy dual

Page 59



011640
White
\$ 125.00

Salient Actuator

Page 64



718063
White
\$ 110.00

Sphera Actuators

Page 64



605001
White
\$ 60.00



605004
Polished Chrome
\$ 80.00



605274
Small Flush
Polished Chrome
\$ 65.00



605264
Large Flush
Polished Chrome
\$ 65.00



Pneumatic Stainless Steel Flush Plates

Trumpet Page 49



046199
Polished
\$ 895.00



046198
Brushed
\$ 895.00



883245
Brushed Gold
\$ 1195.00



878783
Brushed White
Gold
\$ 1195.00



887609
Brushed Copper
\$ 1195.00

Blink Page 51

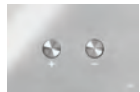

154963
Polished
\$ 335.00



093399
Brushed
\$ 335.00



216622
White
\$ 450.00



878490
Black
\$ 450.00



883246
Brushed Gold
\$ 625.00



878781
Brushed White
Gold
\$ 625.00



887610
Brushed Copper
\$ 625.00



882567
Brushed Gun Metal
\$ 625.00

Mini Trend Page 61



605294
Brushed
\$ 275.00

Mono Trend Page 63



605254
Brushed
\$ 175.00

Floor Mounted Foot Actuator Page 65



605201
Brushed
\$ 215.00

Wall Mounted Foot Actuator Page 65



605301
Brushed
\$ 295.00



MECHANICAL FLUSH PLATES

Experience the exceptional quality of OLI's flush plates in every flush.
Featuring high-quality button mechanics, for precise flushing action.
Available for several models of flush plates, in a variety of finishes.



8.6" (220 mm)

0.787" (2 mm)

LESS

MORE

5.9"
(150 mm)

OLI

883526, Stainless Steel White Matte



LESS IS MORE

Design by **Architect Alessio Pinto**

A natural protagonist in any bathroom decor, whether vintage or contemporary, the LESS IS MORE flush plate conveys an instantly perceptive message thanks to its simple and intuitive shape. Plus and Minus, no more, no less. Reading “more water” or “less water” is easily interpreted when making a decision about which flushing option to choose.

FEATURES

- Design by Architect Alessio Pinto;
- Stainless steel;
- PVD Finish;
- Nylon cords on grey;
- Mechanical actuation;
- Front application;
- Low actuation force <17 N.



Features and Installation

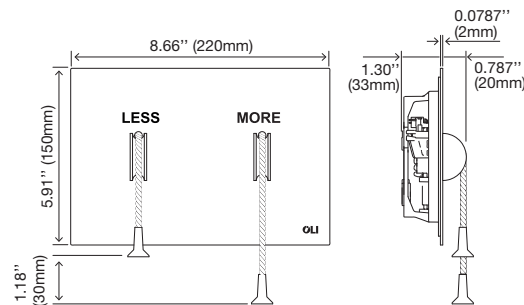

ALESSIO PINTO

Meet the brilliant mind behind our remarkable flush plate design - Architect Alessio Pinto:

“At a glance we realize the meaning of Plus and Minus. All it takes is viewing the cords as analog signs”

Alessio Pinto

883524
Stainless Steel Polished \$ 795.00



883525
Stainless Steel Brushed \$ 795.00



883526
Stainless Steel White Matte \$ 895.00



883527
Stainless Steel Black Matte \$ 895.00



888573
Stainless Steel Brushed Gold \$ 895.00



reddot winner 2021

← 8.46" (215 mm) →

0.07" (2 mm)

↑
5.7" (145 mm)
..... ↓

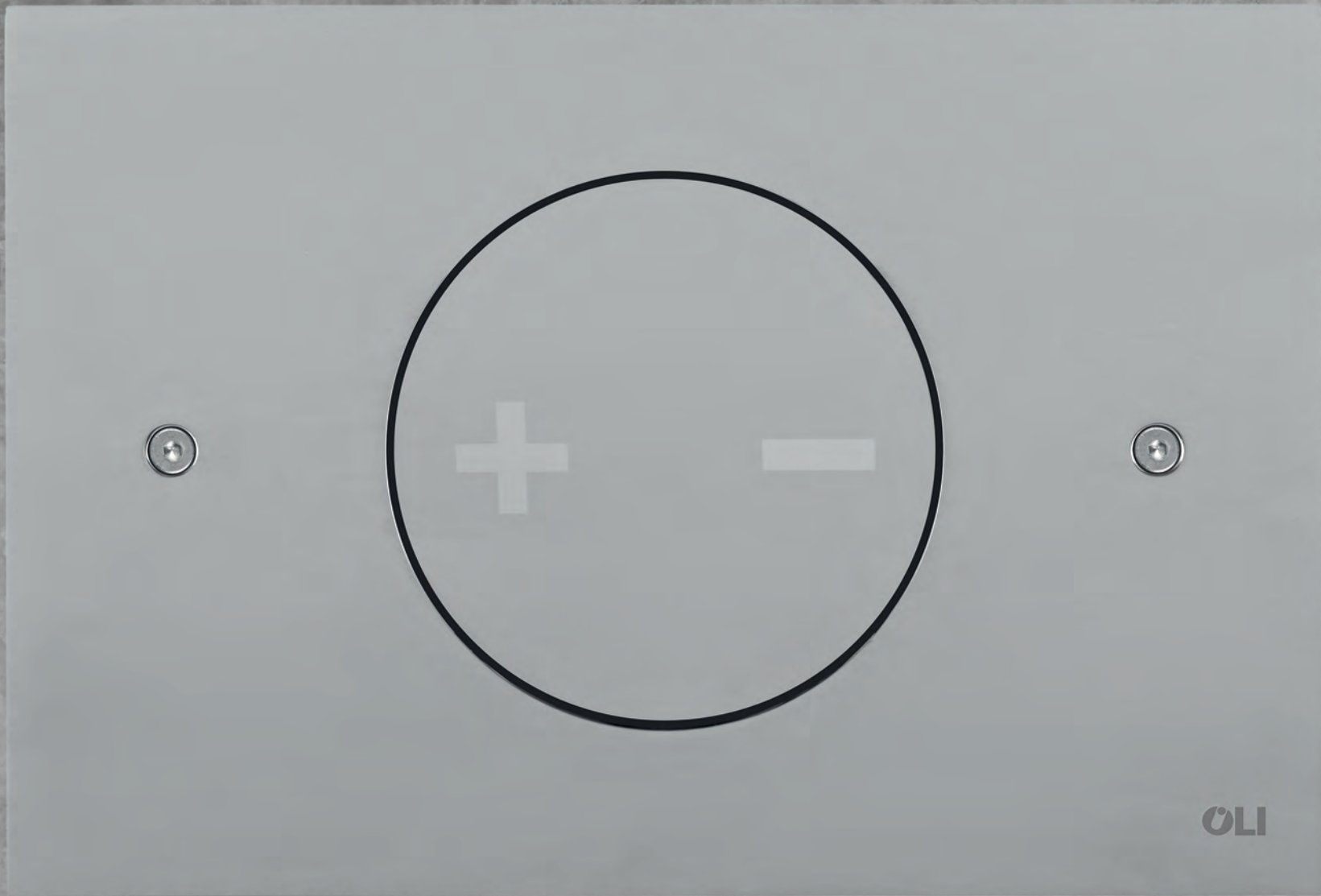

OLI

▲
660002, Brushed Stainless Steel

INO-X 02

Design by **Romano Adolini**

FEATURES

- Dual flush;
- Tilttable button;
- Stainless steel;
- Actuation force < 20 N;
- 2mm thickness;
- Anti-vandal resistance.



Features and
Installation

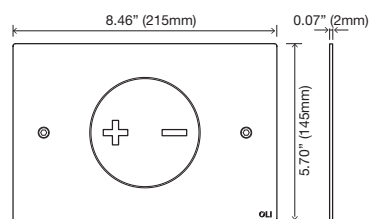

0.07" (2 mm)



9.64" (245 mm)

▲
661006, Brushed
Stainless Steel

OLI



INO-X 06

Design by **Romano Adolini**

FEATURES

- Dual flush;
- Tilttable button;
- Stainless steel;
- Actuation force < 20 N;
- 2mm thickness;
- Anti-vandal resistance.



Features and
Installation

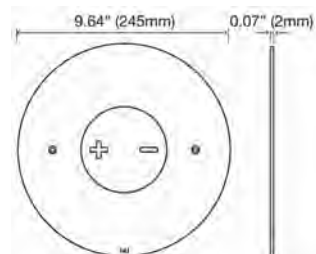

661006
Brushed Stainless Steel

\$795.00





9.1" (230 mm)

0.25" (6.5 mm)

5.9"
(150 mm)

▲
152954, Polished gold

OLI



GLOBE

FEATURES

- ABS: high resistance to scratches;
- Mechanical actuation;
- Actuation force < 20 N;
- Anti-bacterial finish available.



Features and Installation

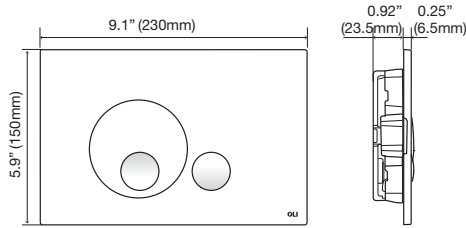

152949 Glossy White	\$ 145.00

885464 White Bacterial Proof	\$ 145.00

152950 Polished chrome	\$ 170.00

152951 Matte chrome	\$ 170.00

152952 Black soft-touch	\$ 260.00

152953 Grey soft-touch	\$ 285.00

152954 Polished Gold	\$ 375.00

BATHROOMS WITH ANTIBACTERIAL SURFACES

In environments where hygiene is paramount, such as hospitals, senior homes, and public spaces, OLI introduces the Bacterial proof model. This innovation is specifically designed to combat the spread of bacteria, reinforcing the importance of cleanliness in shared areas.

0.25" (6.5 mm)
0.30" (7.8 mm inox)

10.03" (255 mm)

5.9"
(150 mm)

OLI

659042, White Matte



SLIM

FEATURES

- ABS high resistance to scratches;
- Mechanical actuation;
- 0.25" Thickness;
- Actuation force < 20 N.



Features and Installation



659041
Glossy White

\$ 145.00

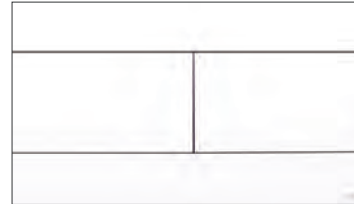

659044
Polished chrome

\$ 170.00



154962
Polished Gold

\$ 395.00



Slim Matte Collection

659046
Matte chrome

\$ 170.00



659042
White Matte

\$ 190.00

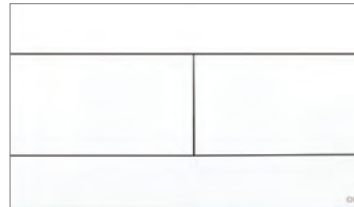

659058
Grey Matte

\$ 190.00



659056
Black Matte

\$ 190.00

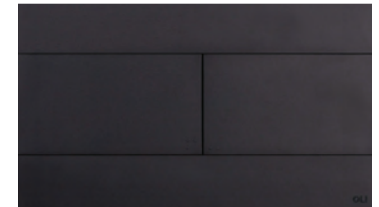

SLIM INOX STAINLESS STEEL

FEATURES

- Mechanical actuation;
- Actuation force < 20 N;
- PVD Finish;
- SLIM INOX ABS with brushed Stainless steel cover;
- 0.30" (7.8 mm) thick.



Features and Installation

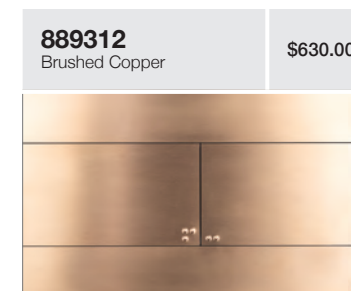
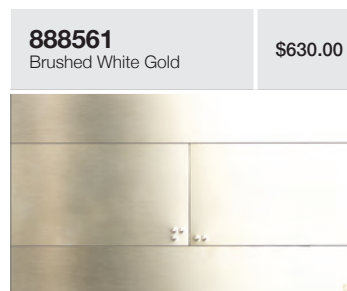
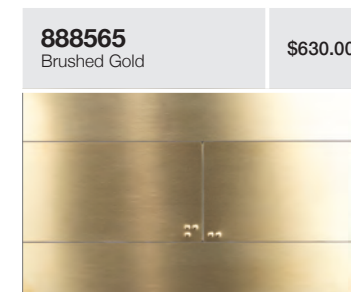
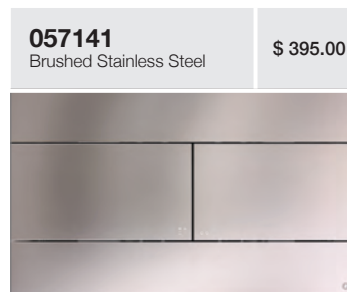
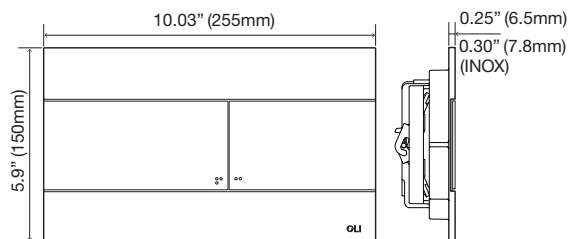

0.15" (4 mm inox)
0.23" (6 mm)

8.66" (220 mm)

5.9"
(150 mm)



054564, Stainless steel - Brushed

OLI



OCEANIA

With the Oceania mechanical flush plate, OLI has achieved the goal of combining simple aesthetic design with elegantly unique features.

FEATURES

- Tempered glass and/or Stainless steel;
- Mechanical actuation;
- Actuation force < 20 N;
- PVD Finish;
- Tiltable button;
- Vandal resistant;
- Different combinations of materials and finishes.



Features and Installation

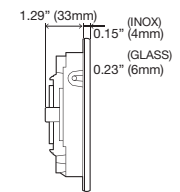
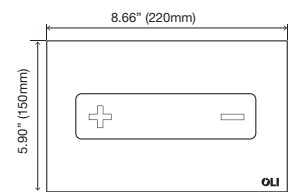

054554 White Glass	\$ 575.00

054557 Black Glass	\$ 575.00

054558 Stainless Steel Button - White Glass	\$ 695.00

054562 Stainless Steel Button - Black Glass	\$ 695.00

054561 Stainless Steel - Polished	\$ 575.00

054564 Stainless Steel - Brushed	\$ 575.00

882412 Stainless Steel Brushed Gold	\$ 695.00

OCEANIA MIA

The Oceania Mia recessed design allows to insert any wall finish (wood, marble, ceramic, etc.) for a personalized and unique plate.



054563 Mech (customizable)	\$ 475.00
--------------------------------------	-----------

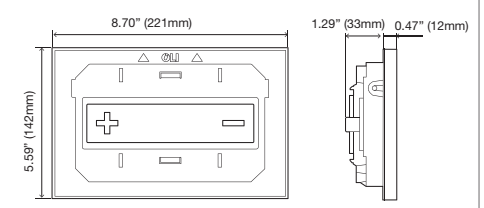

0.25" (6.5 mm)

9.05" (230 mm)

5.9"
(150 mm)

OLI

▲
139186 - Matte chrome

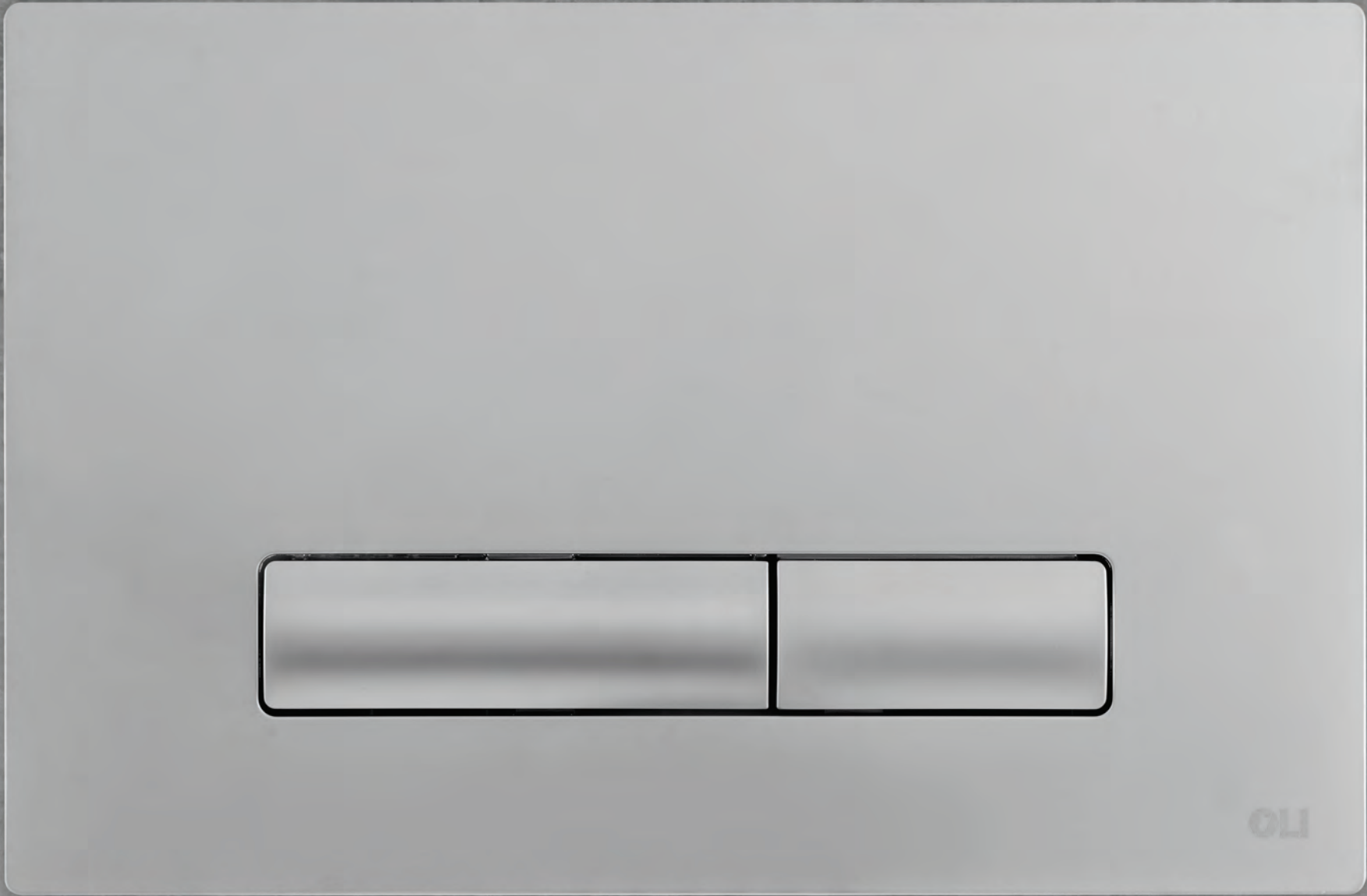



GLAM

FEATURES

- ABS: high resistance to scratches;
- Mechanical actuation;
- Actuation force < 20 N;



Features and Installation



BATHROOMS WITH ANTIBACTERIAL SURFACES

In environments where hygiene is paramount, such as hospitals, senior homes, and public spaces, OLI introduces the Bacterial proof model. This innovation is specifically designed to combat the spread of bacteria, reinforcing the importance of cleanliness in shared areas.

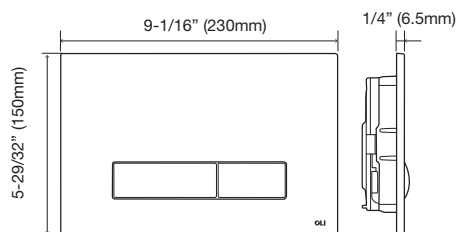

139184 Glossy White	\$ 145.00

885578 White Glossy Antibacterial	\$ 145.00

139185 Polished Chrome	\$ 160.00

139186 MATTE Chrome	\$ 190.00

139187 Black Soft-Touch	\$ 190.00

0.25" (6.5 mm)

9.05" (230 mm)

5.9"
(150 mm)

OLI

▲
885576 - White Glossy Antibacterial

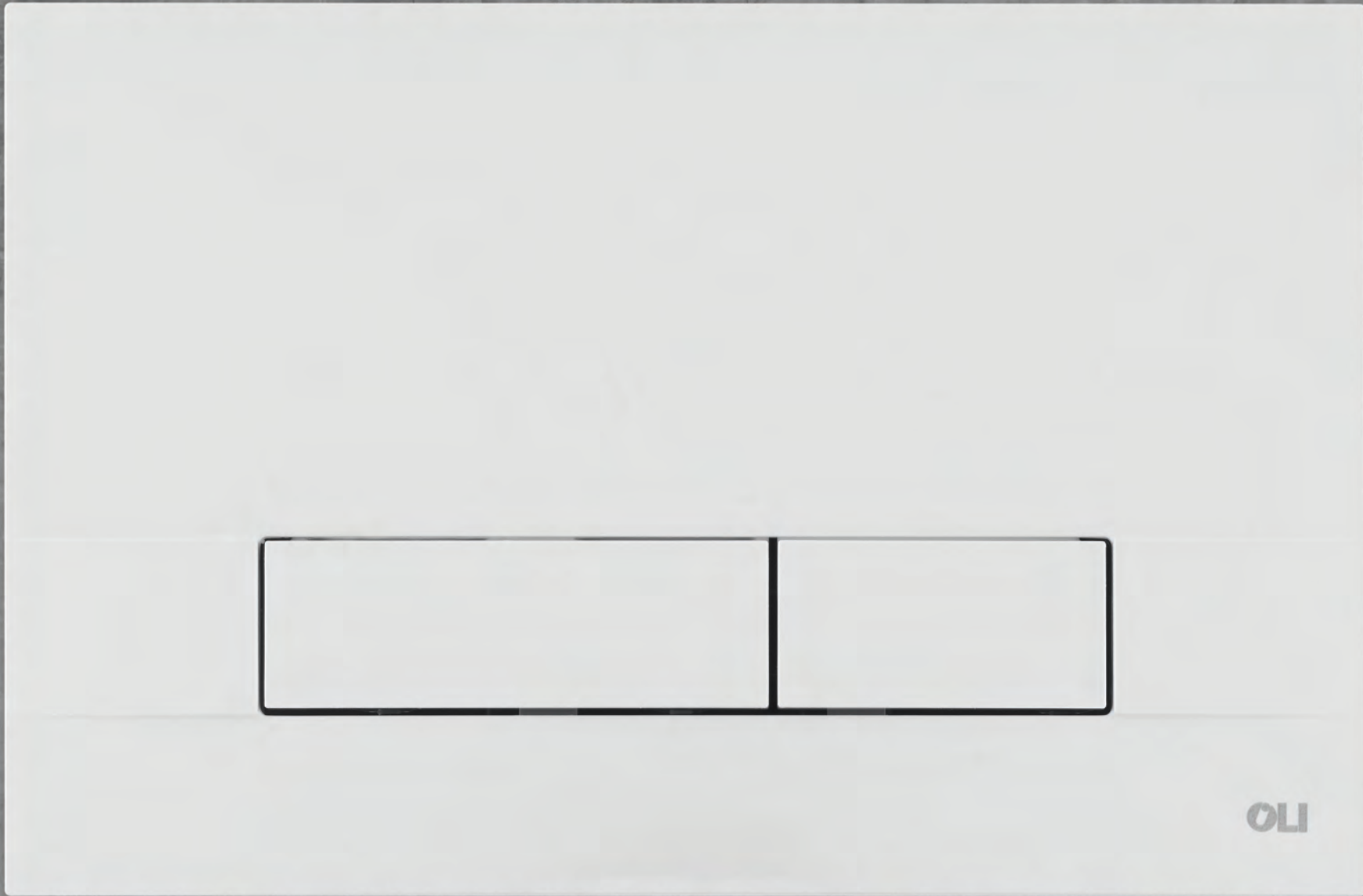

NARROW

FEATURES

- ABS: high resistance to scratches;
- Mechanical actuation;
- Actuation force < 20 N;



Features and Installation



BATHROOMS WITH ANTIBACTERIAL SURFACES

In environments where hygiene is paramount, such as hospitals, senior homes, and public spaces, OLI introduces the Bacterial proof model. This innovation is specifically designed to combat the spread of bacteria, reinforcing the importance of cleanliness in shared areas.

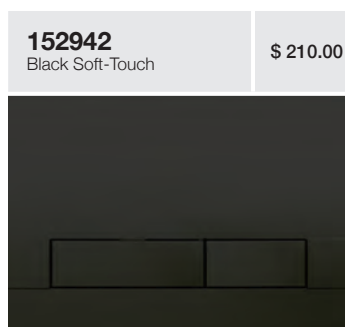
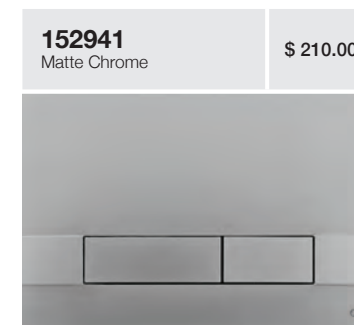
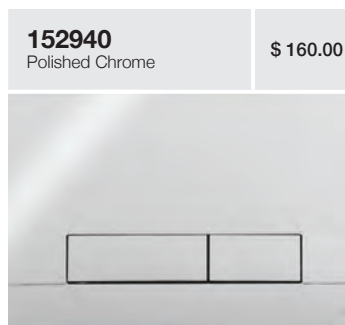
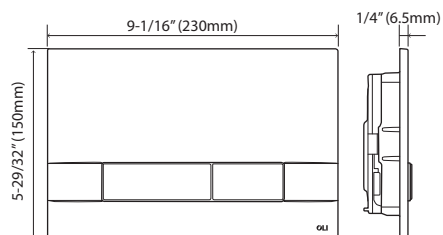

9.05" (230 mm)

0.25" (6.5 mm)

5.9" (150 mm)

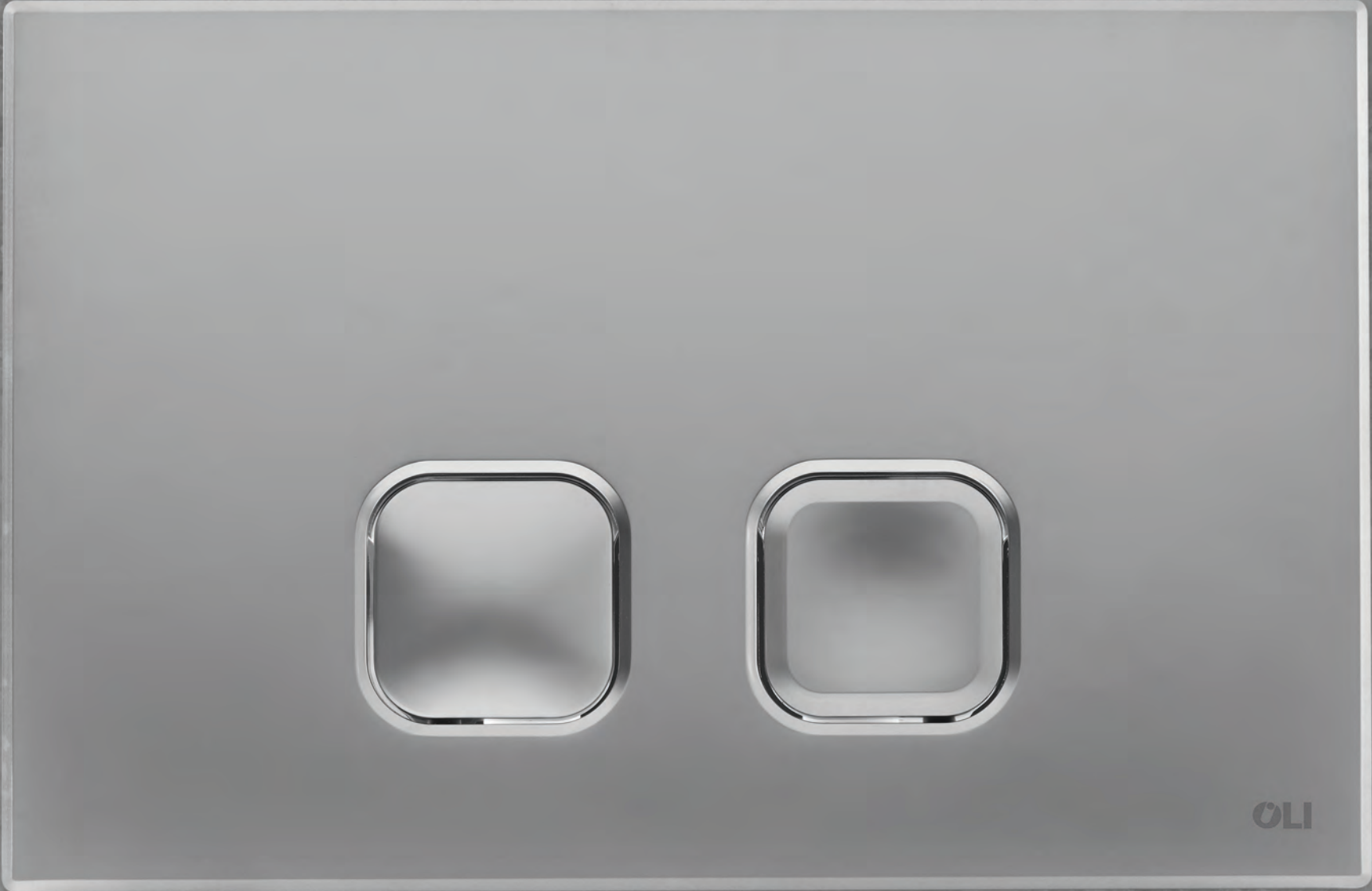

▲
070828 - Matte chrome

PLAIN

FEATURES

- ABS: high resistance to scratches;
- Mechanical actuation;
- Actuation force < 20 N.



Features and
Installation

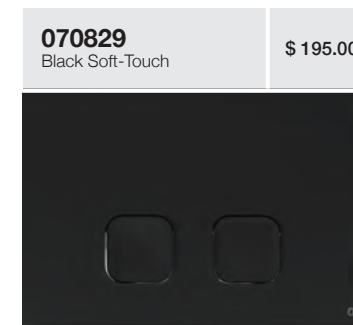
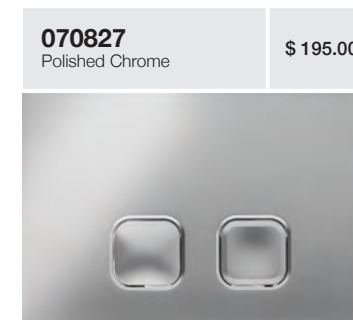
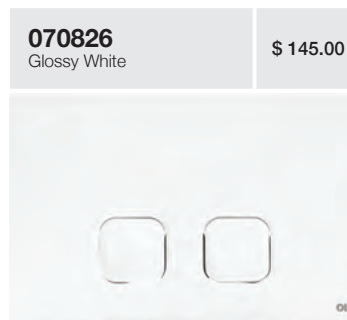
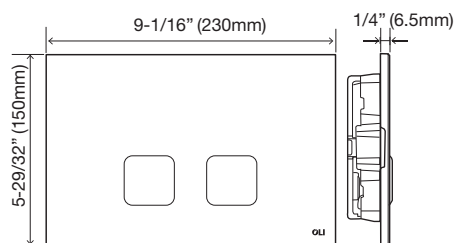

9.56" (243 mm)

0.6" (17 mm)

6.4" (163 mm)



OLI

▲
656006 - Matte Chrome

METAL

The Power of Metal: Unmatched Strength and Durability. Our metal flush plates are synonymous with robustness and unbeatable resistance. Crafted from the toughest materials, they are also vandal-resistant, making them the ideal choice for installations in public restrooms.

FEATURES

- Metal material;
- Mechanical actuation;
- Actuation force < 20 N;
- Vandal resistant.



Features and Installation



Public Spaces

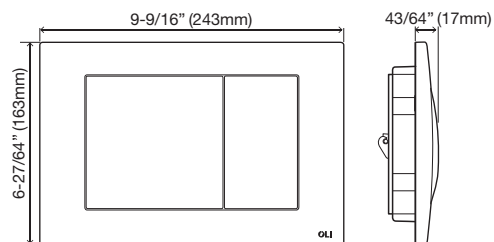

656004
Polished Chrome

\$ 430.00



656006
Matte Chrome

\$ 490.00



9.64" (245 mm) 0.6" (17 mm)

6.29" (160 mm)

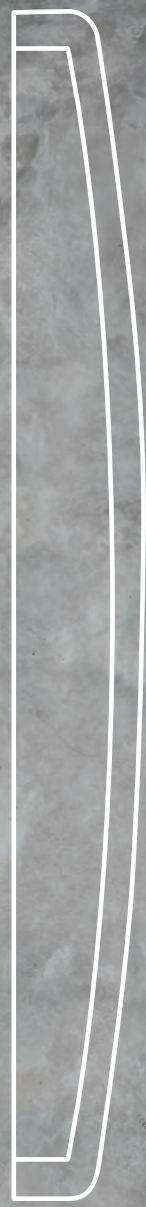

▲ 640586, Matte chrome

RIA

FEATURES

- ABS: high resistance to scratches;
- Anti-bacterial finish available;
- Mechanical actuation;
- Actuation force < 20 N.



Features and Installation

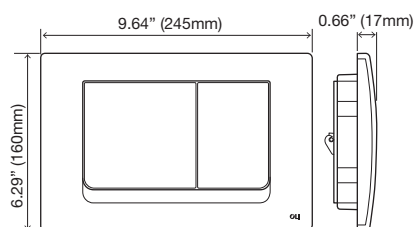

BATHROOMS WITH ANTIBACTERIAL SURFACES

In environments where hygiene is paramount, such as hospitals, senior homes, and public spaces, OLI introduces the Bacterial proof model. This innovation is specifically designed to combat the spread of bacteria, reinforcing the importance of cleanliness in shared areas.

9.64" (245 mm) 0.6" (17 mm)

6.29" (160 mm)



▲
010244, Polished chrome

RIA START STOP

Start and stop the flush at your convenience or let the flush finish its cycle.

FEATURES

- ABS: high resistance to scratches;
- Mechanical actuation;
- Actuation force < 20 N.



Features and
Installation

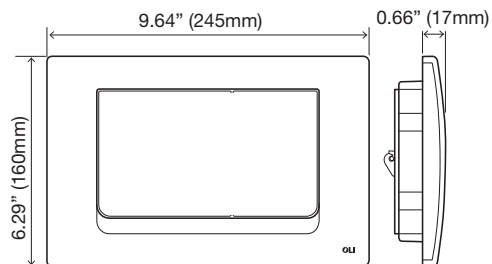



PNEUMATIC FLUSH PLATES

Products marked with  comply with the American Disability Act (ADA) when installed per the requirements of the latest Ada Act Accessibility guidelines (ADA AG) and/or ICC/ANSI A117.1.

PNEUMATIC FLUSH PLATES

Pneumatic flush plates are known for their soft press actuation, but they can also be used for alternate installations of up to 2 meters away from the carrier, optimizing your comfort.



← 8.47" (215 mm) →

0.07" (2 mm)



← 1.16" (29.7 mm) →

↑
5.70"
(145 mm)
..... ↓

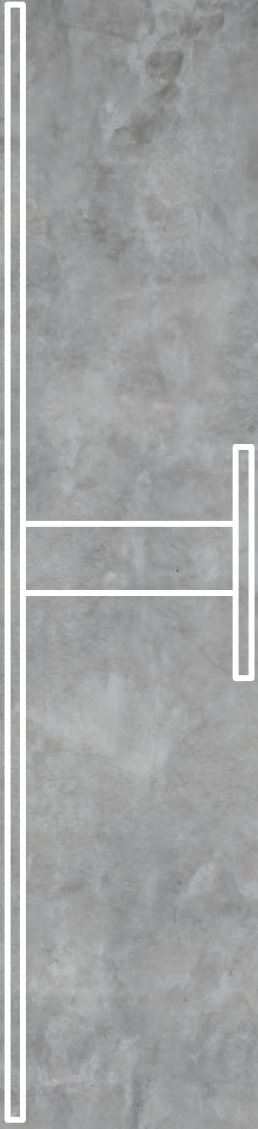

▲
046198, Brushed Stainless Steel

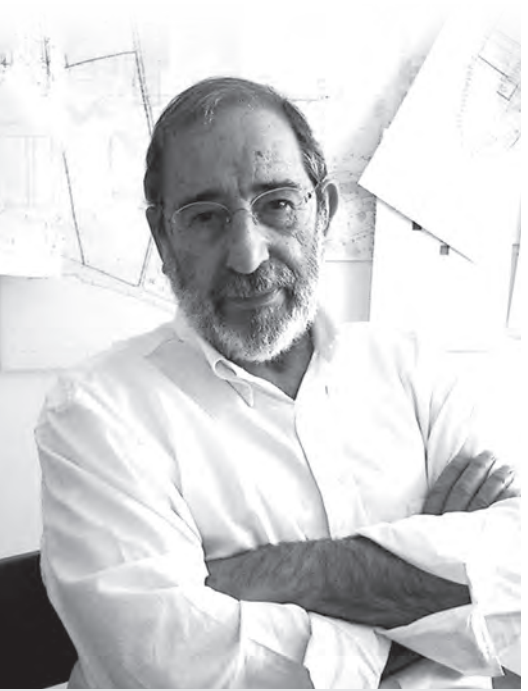

TRUMPET

Designed by **Architect Siza Vieira**

FEATURES

- Stainless steel material;
- Pneumatic actuation;
- Actuation force <20N;
- PVD Finish;
- Pneumatic conversion kit included.



Features and Installation



The Trumpet flush plate is the perfect combination of elegance and harmony, both characteristics of a trumpet. In 2016, the Trumpet was selected Best of Category for the Archiproducts Design Awards one of the most prestigious awards of Architecture and Design worldwide.

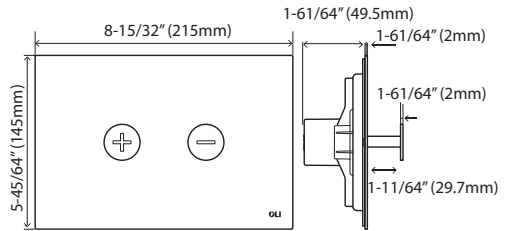

"I am very pleased with the prestigious "Best of Category 2016" award for the Trumpet flush plate. The quality achieved is due to the competent and committed contribution of the technicians at OLI. It was a pleasure to evolve the design of the flush plate with them."

Álvaro Siza

046199 Polished Stainless Steel	\$ 895.00
---	-----------



046198 Brushed Stainless Steel	\$ 895.00
--	-----------



883245 Brushed Gold	\$ 1195.00
-------------------------------	------------

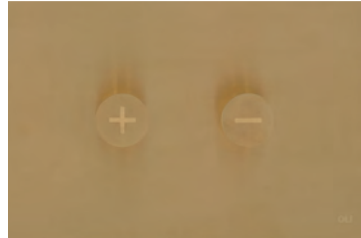

878783 Brushed White Gold	\$ 1195.00
-------------------------------------	------------



887609 Brushed Copper	\$ 1195.00
---------------------------------	------------

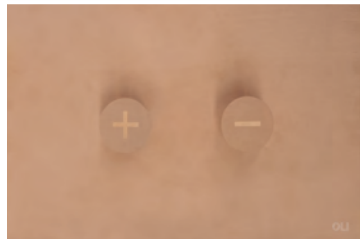

8.46" (215 mm)

0.11" (3 mm)
0.07" (2 mm)

5.70"
(145 mm)



+



-

OLI

▲
093399, Brushed Stainless Steel

BLINK

FEATURES

- Stainless steel material;
- Pneumatic actuation;
- Actuation force <20N;
- PVD Finish;
- Pneumatic conversion kit included.



Features and Installation

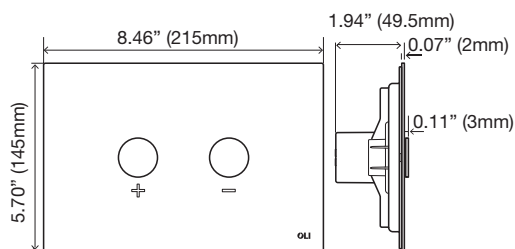

154963 Polished Stainless Steel	\$ 335.00

093399 Brushed stainless steel	\$ 335.00

216622 White Stainless Steel	\$ 450.00

878490 Black Stainless Steel	\$ 450.00

883246 Brushed Gold	\$ 625.00

878781 Brushed White Gold	\$ 625.00

887610 Brushed Copper	\$ 625.00

882567 Brushed Gun Metal	\$ 625.00

9.05" (230 mm)

0.55" (14 mm)

5.74" (146 mm)

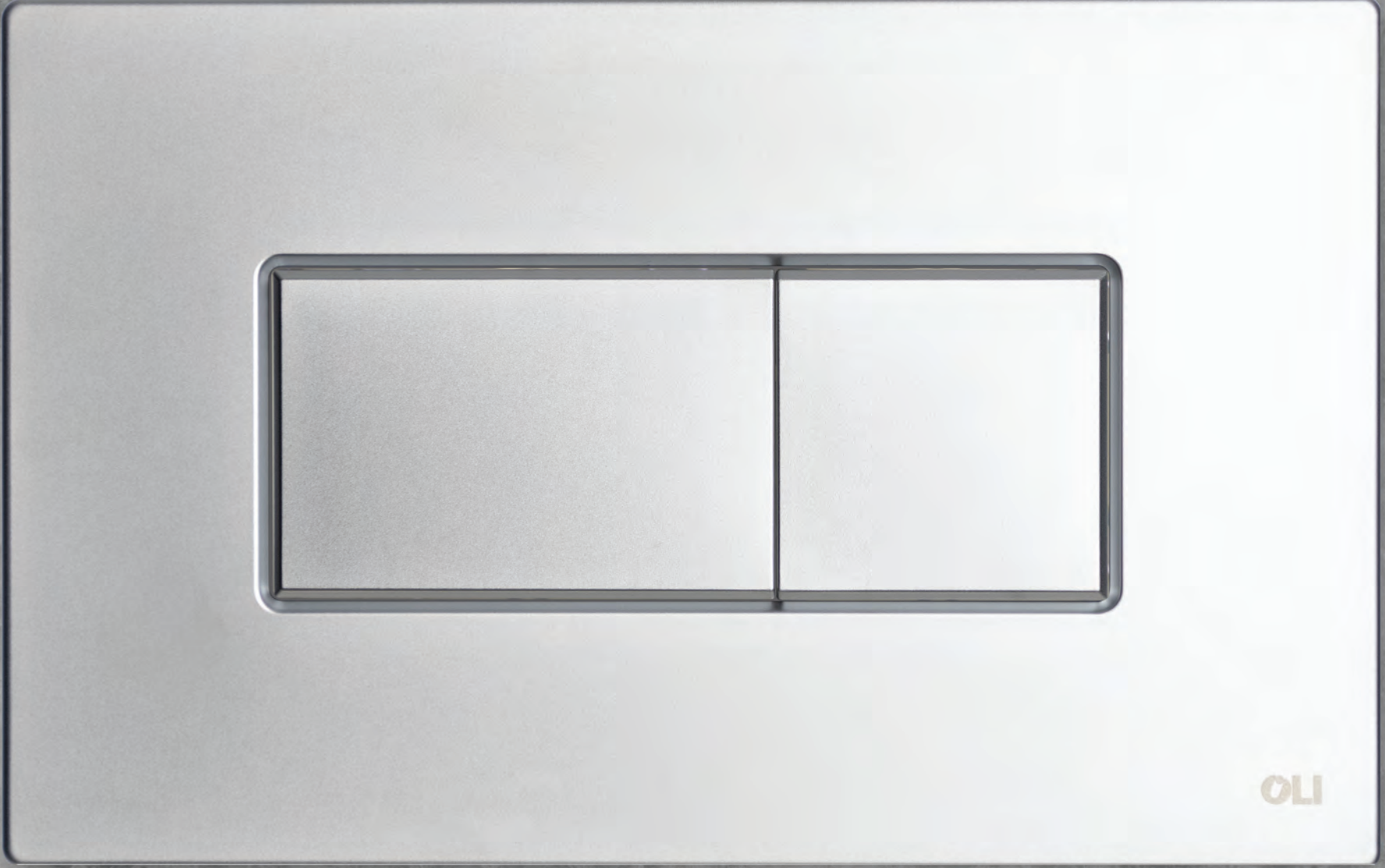

641006, Matte chrome

KARISMA

FEATURES

- ABS: high resistance to scratches;
- Pneumatic actuation;
- Actuation force < 20 N;
- Pneumatic conversion kit included.



Features and Installation

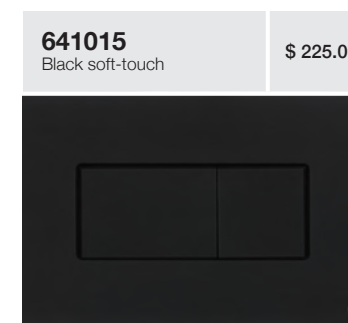
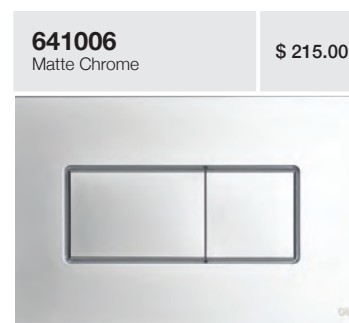
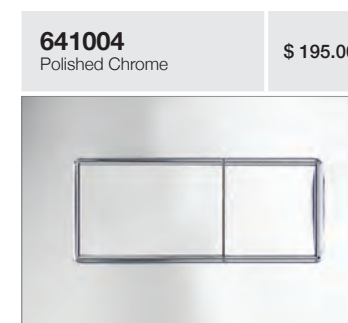
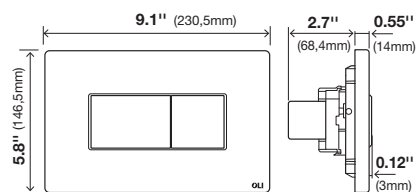

Important:

25mm distance required from finished wall to base of yellow protective box to ensure proper installation.



SALINA

The link between traditional and modern. Embrace the minimalist elegance of the Salina flush plate. Its compact size, available in mono or two-color finishes, combines the sophistication of soft-touch materials with the choice of chrome or classic white, allowing a customized bathroom with effortless style.

FEATURES

- ABS: high resistance to scratches;
- Pneumatic actuation;
- Actuation force < 20 N;
- Pneumatic conversion kit included.



Features and Installation

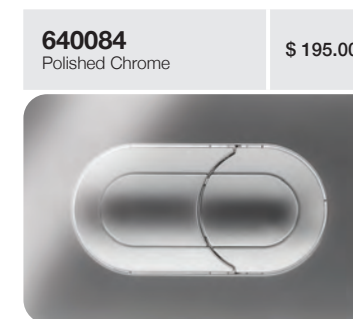
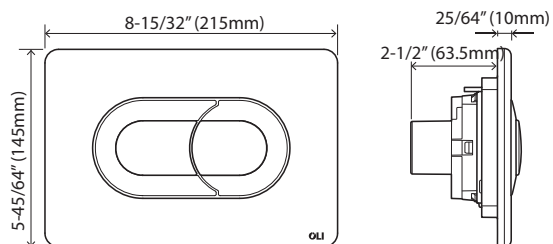

Important:

25mm distance required from finished wall to base of yellow protective box to ensure proper installation.

5.79" (147 mm)

0.2" (5 mm)

5.79"
(147 mm)



OLI

▲
022238, White tempered glass



SM15

ALTERNATE INSTALLATION

For side wall installation, cannot be installed directly on carrier

Design by **Architect Souto de Moura**

FEATURES

- Designed by Architect Souto de Moura;
- Pneumatic actuation;
- White tempered glass material;
- Buttons in ABS polished chrome
- Actuation force <20N;
- Pneumatic conversion kit included;
- Requires Inspection plate **code 880390** p.68
- Requires pneumatic pipes **code 043234** p.69



Features and Installation



022238 White Tempered Glass	\$ 795.00
---------------------------------------	-----------

SOUTO DE MOURA

Souto de Moura is a renowned Portuguese architect who has been presented with various international awards, such as, the Gold Medal of Heinrich Tessenow Foundation in 2001; the Pritzker Award in 2011; the Wolf Prize of Arts in 2013; just to name a few.

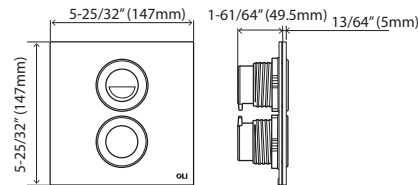

4.64" (118 mm)

5" (127 mm)

4.64" (118 mm)

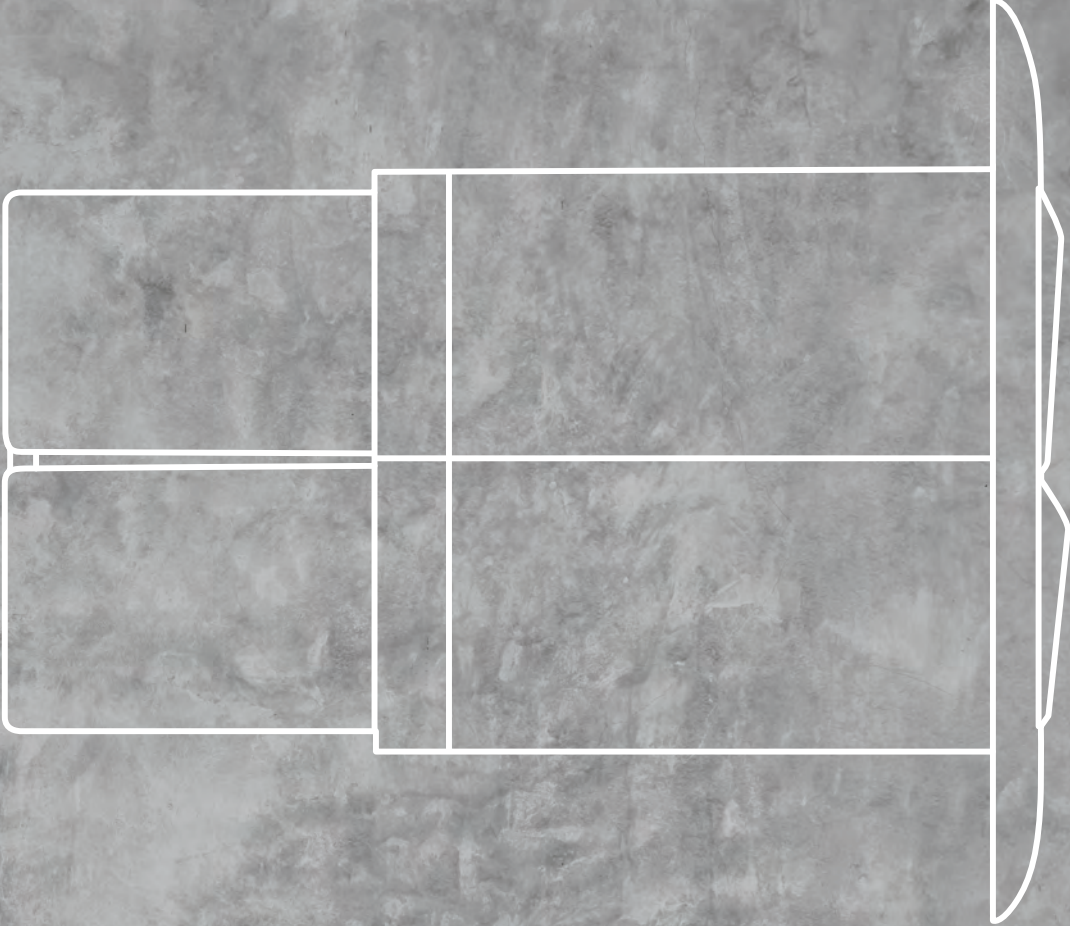

▲
011640, White

EASY DUAL

ALTERNATE INSTALLATION

For side wall installation, cannot be installed directly on carrier

FEATURES

- Soft-touch finish;
- ABS: high resistance to scratches;
- Pneumatic actuation;
- Vandal resistant;
- Adjustable buttons: 0", 0.70" or 1.25" (0mm, 18mm or 32mm);
- Compliant with safety regulations against fire (ERP);
- Pneumatic conversion kit included;
- Requires Inspection plate **code 880390** p.68
- Requires pneumatic pipes **code 043234** p.69



Features and Installation



Public Spaces



011640
White

\$ 125.00

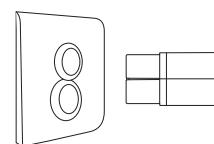
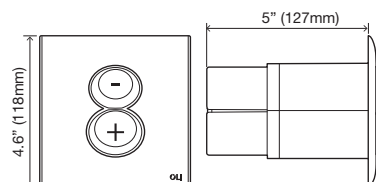

0mm

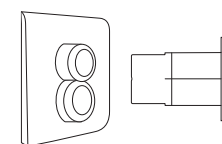

18mm

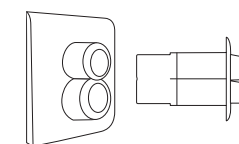

32mm

6.1" (155 mm) 0.08" (2 mm)

3.34" (85 mm)



605294, Brushed Stainless Steel

MINI TREND

ALTERNATE INSTALLATION

For side wall installation, cannot be installed directly on carrier

FEATURES

- Stainless steel material;
- Pneumatic actuation;
- Buttons in ABS polished chrome
- Vandal resistant;
- Pneumatic conversion kit included;
- Requires Inspection plate **code 880390** p.68
- Requires pneumatic pipes **code 043234** p.69



Features and Installation



Public Spaces

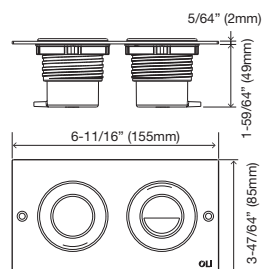
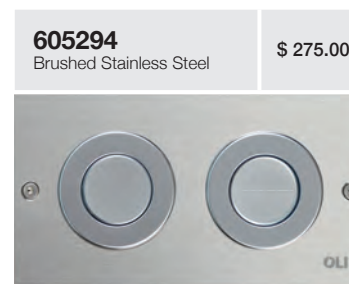

←.....3.34" (85 mm)→ 0.08" (2 mm) ←→

3.34" (85 mm)



▲ 605254, Brushed Stainless Steel



MONO TREND

ALTERNATE INSTALLATION

For side wall installation, cannot be installed directly on carrier

FEATURES

- Stainless steel material;
- Single flush;
- Pneumatic actuation;
- Vandal resistant;
- Pneumatic conversion kit included;
- Requires Inspection plate **code 880390** p.68
- Requires pneumatic pipes **code 043234** p.69



Features and Installation



Public Spaces



605254
Brushed Stainless Steel

\$ 175.00

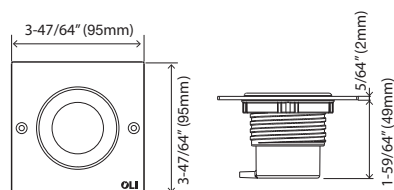

PNEUMATIC ACTUATORS

ALTERNATE INSTALLATION

For side wall installation, cannot be installed directly on carrier

718063 Salient Actuator White	\$ 110.00
---	-----------

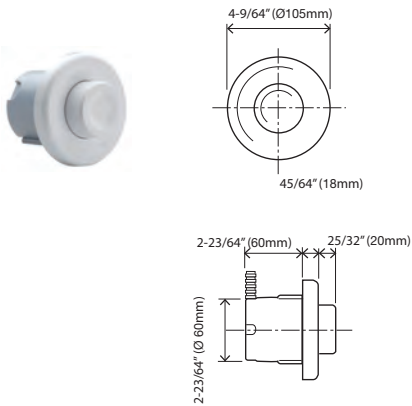

605004 Polished Chrome	\$ 80.00
----------------------------------	----------

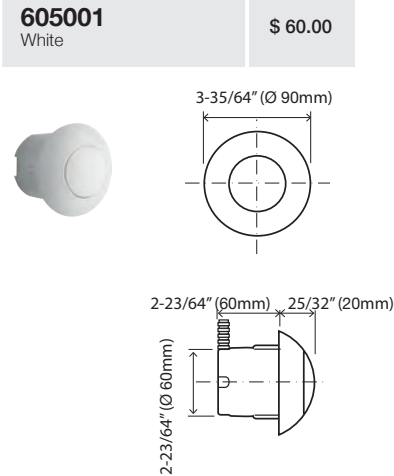

605274 Sphera - Polished chrome	\$ 65.00
---	----------

Small Flush

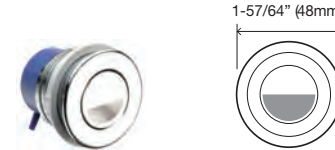

605264 Sphera + Polished chrome	\$ 65.00
---	----------

Large Flush

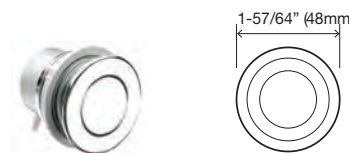

FEATURES

- ABS material;
- Single flush;
- Pneumatic actuation.



If used with a push plate

- Requires duplex Kit for remote flushing
code 216252 p.68

If not used with a push plate

- Requires Pneumatic kit
code 601527 p.68
- Requires Inspection plate
code 880390 p.68
- Requires pneumatic pipes
code 043234 p.69



PNEUMATIC ACTUATORS

FOOT ACTUATORS

FEATURES

- Stainless steel material;
- Floor installation;
- Single flush;
- Pneumatic actuation;
- Anti-sliding push button;
- Vandal resistant.

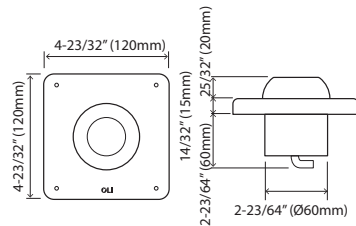

If used with a push plate

- Requires duplex Kit for remote flushing **code 216252** p.68

If not used with a push plate

- Requires Pneumatic kit **code 601527** p.68
- Requires Inspection plate **code 880390** p.68
- Requires pneumatic pipes **code 043234** p.69

ALTERNATE INSTALLATION

For floor installation, cannot be installed directly on carrier

FEATURES

- Stainless steel material;
- Lower wall installation;
- Single flush;
- Pneumatic actuation;
- Anti-sliding push button;
- Vandal resistant.

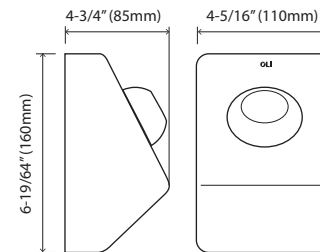
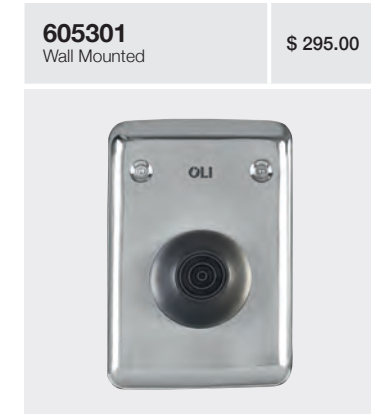

If used with a push plate

- Requires duplex Kit for remote flushing **code 216252** p.68

If not used with a push plate

- Requires Pneumatic kit **code 601527** p.68
- Requires Inspection plate **code 880390** p.68
- Requires pneumatic pipes **code 043234** p.69

ACCESSORIES

106572

Flow reducer for oli 74 plus

\$ 20.00

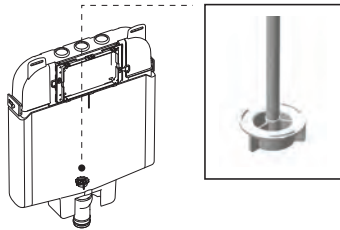

FLOW RATE REDUCER

- Can be installed after the carrier is installed inside the wall.

885108

Eccentric set connection 25mm

\$ 295.00

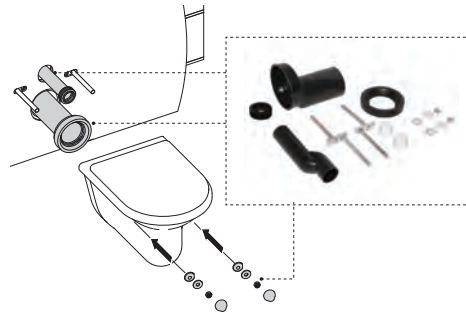

ECCENTRIC SET CONNECTION 0.98" (25MM)

- Accessory sets to enable the correction of incorrect applications;
- Toilet connection Ø3.54" (Ø90mm);
- Connection WC pipe Ø1.77x 7.08" (Ø45x180).

011229

Longer sleeves for wall-hung WC pan

\$ 120.00

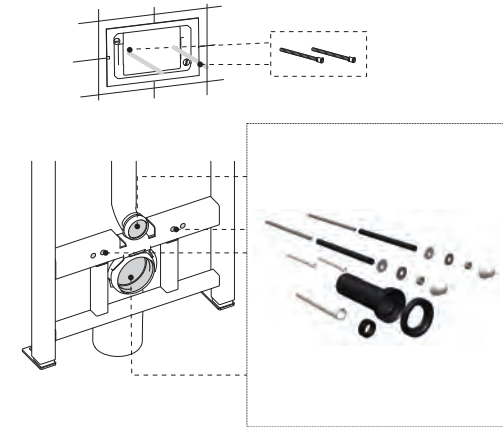

LONGER SLEEVES FOR WALL HUNG TOILETS

- Outlet pipe Ø3.54x4.92x11.8" (Ø90xØ125x300mm);
- Rubber seal for outlet pipe Ø4.92" (Ø125mm);
- Connection WC pipe Ø1.77x 11.0" (Ø45x280mm);
- Rubber seal for WC pipe Ø1.77" (Ø45mm);
- 0.47x 11.8" M (12x300mm) rods for wall-hung toilets fixation;
- Counter plate fixation screws;
- Toilet fixing material.

620071

Acoustic insulation for wall-hung toilet and bidet

\$ 40.00

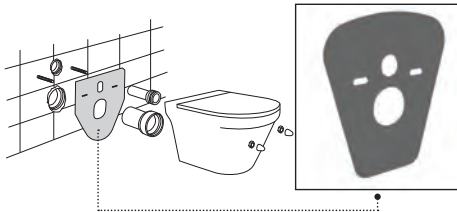

ACOUSTIC INSULATION FOR WALL HUNG TOILET AND BIDET

- Acoustic insulation in expanded polyethylene;
- Avoids direct contact between the sanitaryware and the tile.

108380

Horizontal outlet WC

\$ 95.00

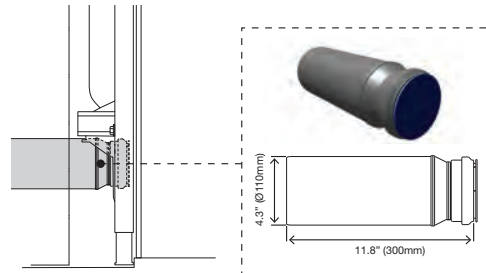

HORIZONTAL OUTLET TOILET

- Length 11.8" (300mm);
- Exit 4.33" (Ø110mm);
- Toilet connection Ø3.5" (Ø90mm).

880096

Waste pipe adapter for 4 inch connection

\$ 30.00

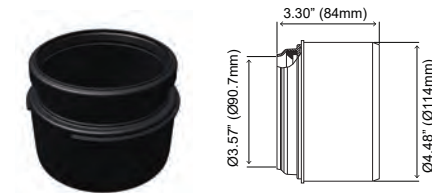

WASTE PIPE ADAPTER FOR 4 INCH CONNECTION

ACCESSORIES

216252
Kit Duplex

\$ 175.00

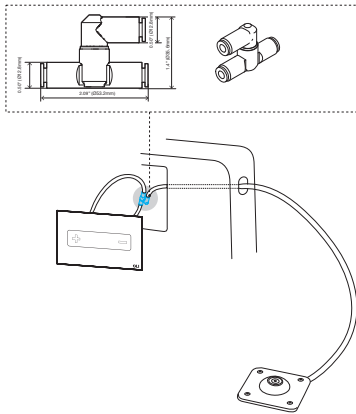

KIT DUPLEX

- 2 points of actuation on the same carrier;
- Only for pneumatic flush plates;
- Single flush.

885233

Bypass connector

\$ 345.00



BYPASS CONNECTOR

- Connector between the flush pipe and the outlet bend;
- The flushing can be tested before the toilet is installed.

880390

Decorative inspection plate brushed stainless steel

\$ 270.00

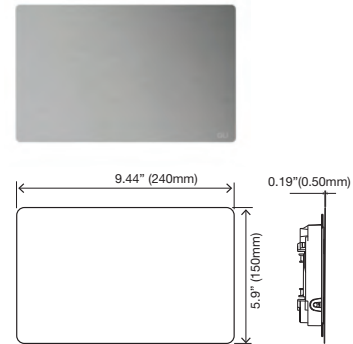

SEAMLESS INSPECTION PLATE

- Customize with any wall finish;
- Inspection plate;
- Stainless steel material;
- Compatible with pneumatic in-wall carriers;
- Vandal resistant;
- 0.5mm thick.



601527

Pneumatic Kit Oli74 Plus

\$ 120.00

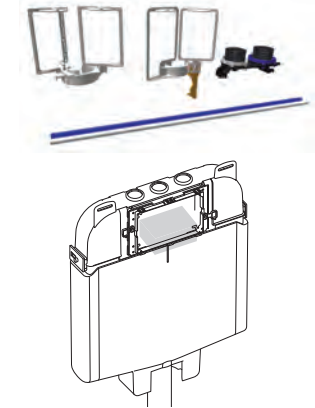

PNEUMATIC KIT FOR OLI74 PLUS

- 2 pneumatic pipes with 13.75" (350mm) of tubing;
- Outlet valve pneumatic anchors;
- Pneumatic bellows.

043234
Pneumatic Pipes

\$25.00

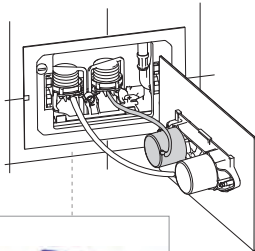

PNEUMATIC PIPES

- Pneumatic pipes x2;
- 118" (3m) each.

049544
Protection Pipe

\$25.00

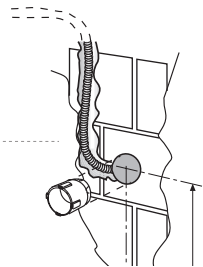

PROTECTION PIPE

- Protection pipe 71" (1.8m) pneumatic connections.

FOR FLOOR TOILETS WITH TANKS

878735

FILL VALVE IVC102 PLUS 15/16

\$25.00



FILL VALVE IVC102 PLUS 15/16

- Quick filling;
- UPC Certified;
- Bottom inlet valve with 1/2" brass, plastic or 15/16" in plastic connection;
- Delayed refilling inlet valve: it starts after the outlet valve is in the close position;
- Height adjustable;
- Silent inlet valve, class I;
- Integrated filter can be cleaned;
- Counter pressure closing system (hydraulic);
- Dynamic pressure functioning range: 0.5-6bar;
- Maximum static pressure: 16bar;
- Anti-backflow function.

Warranty Terms

1. WARRANTY PERIODS for OLI products:
 - a) In-wall flushing carriers - 10 (ten) years;
 - b) Flushing mechanisms (taps and valves) – 10 (ten) years;
 - c) Push plates and push buttons – 10 (ten) years;
 - d) Fixtures, and fast-wearing parts, specifically rubber seals or similar products – 2 (two) years;
 - e) All other products – 2 (two) years;
2. The warranty period starts on the purchase date by the first final Consumer. The sales document, corroborating the sales date of the OLI product and the respective serial number, certifies the start date of the warranty. In the event of a subsequent purchase, or any alteration in proprietorship or user, the warranty period shall continue for the remainder the warranty period and shall continue unaltered relative to all other aspects of the warranty.
3. This warranty is also applicable to subsequent substitution parts for those determined to be defective until the end of the warranty period for the product of which they are a part, or up to two years after their application if the remaining warranty period for the product is less than two years. The repair or substitution of a product or a part does not renew the initial warranty period.
4. This warranty is only valid if the product has been correctly installed, in accordance with the installation instructions and the information contained in the catalogues and manuals provided by OLI. In situations where information is not covered in the aforementioned resources, installation should be carried out in accordance with the standards, rules and technical specifications contained in the legislation in effect, applicable to the type of devices and mechanisms in question.
5. The applicability of this warranty also depends on the use considered to be normal for the products, the operating conditions (ex. pressure, temperature, etc.) and the type of liquid used, which should have values within the parameters indicated in the catalogues or manuals provided by OLI.
6. The flush pipes are used for other liquids other than network water. Therefore, the standards relative to the resistance of polyethylene (PE), polypropylene (PP) and polyvinyl chloride (PVC) should always be respected.
7. Products with missing parts or which are defective at the time of installation, as well as during pressure tests, should not be used.
8. OLI products should not be used with other products which do not have local national Quality Approvals/Certificates.
9. Warranty claim should be accompanied by a copy of the sales receipt.
10. This warranty is immediately terminated and is not extended to any equipment or part that has been damaged or become inoperative as a result of the following:
 - a) Accident, fall, fire, flooding and inappropriate, abusive or negligent use;
 - b) Use of parts or accessories which have not been manufactured or provided by OLI, or whose provision and/or manufacture have not been expressly authorised by OLI;
 - c) Unauthorised alterations to the equipment;
 - d) Breaking of any warranty seal or removal of any label with the serial number or legally mandatory marking;
 - e) Assistance, repairs or substitutions carried out by third parties other than OLI, an authorised reseller or certified technical centre.
11. Under no circumstances does the warranty cover the product's installation.
12. The products are packaged in duly identified packages which fulfil the requirements established in applicable national legislation. OLI cannot be held responsible for material or personal damage resulting from the incorrect or inappropriate use of the packages.
13. Failure to comply with any of the aforementioned clauses releases OLI from responsibilities pertaining to material damage and/or non-material damage which may result.
14. OLI recommends that the packaging materials of its products, after no longer being needed, should be recycled by the appropriate and socially responsible means and processes.
15. In the case of defects or non-conformity of OLI products, a written notification should be sent to the dealer where the product was originally purchased within 60 days of becoming aware of the defect, as long as it was not previously visible, within reason. The appropriate measure shall then be taken to determine the possible defects detected. The notification may also occur by telephone, followed by a written notification to the dealer.

16. Failure to comply with the terms of the aforementioned number may result in the total or partial loss of the right to compensation or of the warranty itself.
17. The notification mentioned in Point 15 of this Warranty should contain the following information:
 - a) Name, address and telephone number of the claimant;
 - b) Identification of the product;
 - c) Entity and place where the product was acquired, as well as the respective purchase date;
 - d) Address of the location where the product was installed;
 - e) Description of the visible losses;
 - f) Type of installation and the materials used (if the claimant has this information);
 - g) Conditions of use, ex. type of system, pressure, temperature, etc. (if the claimant has this information);
 - h) Name, address and telephone number of the company or person who installed the product.
18. Any personal information provided shall be used solely for processing the claim and for contact with the claimant and may be transmitted to the insurance provider to which civil responsibility for damages has been transferred.
19. Any obligation to repair, substitute, reduce the price or reimburse, if this should be the case, shall occur only for OLI products which have a visible marking or identifying logotype, with defects or non-conformities which have been proved through extensive technical verification. If it is concluded that the product is not defective, the expenses paid by OLI shall be invoiced to the claimant. The product's technical standards at the time of its manufacture shall be the basis for its conformity assessment.
20. OLI cannot be directly held responsible by the purchaser if the product's non-conformity results from actions by the resellers (or other commercial agents) of OLI products, namely when non-conformity results from statements made by the sales representative regarding the product, its qualities and use conditions, which are different from the product's indications and instructions, including the information contained in manuals and instruction guides provided with the products or published on the company's website.
21. The consumer's rights and obligations are established according to the local Legal Regime for the Sale and Warranty of Consumer Goods.
22. Any litigation resulting from the terms or interpretation of the present warranty, or of the purchase and sales contract from which the warranty results, is regulated by the local law and resolved in the court of the competent legal jurisdiction where the headquarters of the distributor are located, with express waiver of any other, except in cases where OLI and the beneficiary of the warranty have agreed to settle the litigation in an arbitration court.
23. This warranty binds OLI according to its exact terms, except typographical errors.

A+D WATERS

Oli North American exclusive distributor

1 888 AW-9336

ad-waters.com

info@ad-waters.com



Inspired by water...

OLMKCAT2024EN